

# **USER MANUAL**

## **MPPT SOLAR INVERTER**

**VENUS-8200**  
**VENUS-10200**

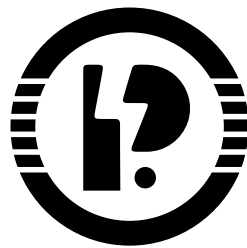

**PRIMAX<sup>®</sup>**  
SOLAR ENERGY

VERSION: 1.0

# Table Of Contents

<b>1.</b>	<b>ABOUT THIS MANUAL</b> .....	<b>3</b>
1.1	PURPOSE.....	3
1.2	SCOPE.....	3
<b>2.</b>	<b>SAFETY INSTRUCTIONS</b> .....	<b>3</b>
<b>3.</b>	<b>INTRODUCTION</b> .....	<b>4</b>
3.1	FEATURES.....	4
3.2	BASIC SYSTEM ARCHITECTURE.....	4
3.3	PRODUCT OVERVIEW.....	5
<b>4.</b>	<b>INSTALLATION</b> .....	<b>6</b>
4.1	UNPACKING AND INSPECTION.....	6
4.2	PREPARATION.....	6
4.3	MOUNTING THE UNIT.....	6
4.4	BATTERY CONNECTION.....	6
4.5	AC INPUT/OUTPUT CONNECTION.....	8
4.6	PV CONNECTION.....	9
4.7	FINAL ASSEMBLY.....	11
4.8	COMMUNICATION CONNECTION.....	11
<b>5.</b>	<b>OPERATION</b> .....	<b>11</b>
5.1	POWER ON/OFF.....	11
5.2	OPERATION AND DISPLAY PANEL.....	11
5.3	LCD DISPLAY ICONS.....	12
5.4	LCD SETTING.....	13
5.5	DISPLAY SETTING.....	20
5.6	OPERATING MODE DESCRIPTION.....	24
5.7	BATTERY EQUALIZATION DESCRIPTION.....	26
5.8	FAULT REFERENCE CODE.....	27
5.9	WARNING INDICATOR.....	28
<b>6.</b>	<b>CLEARANCE AND MAINTENANCE FOR ANTI-DUST KIT</b> .....	<b>29</b>
6.1	OVERVIEW.....	29
6.2	CLEARANCE AND MAINTENANCE.....	29
<b>7.</b>	<b>SPECIFICATIONS</b> .....	<b>30</b>
	TABLE 1 LINE MODE SPECIFICATIONS.....	30
	TABLE 2 INVERTER MODE SPECIFICATIONS.....	31
	TABLE 3 TOW LOAD OUTPUT POWER.....	31
	TABLE 4 CHARGE MODE SPECIFICATIONS.....	32
	TABLE 5 GRID-TIE OPERATION.....	32
	TABLE 6 GENERAL SPECIFICATIONS.....	32
<b>8.</b>	<b>TROUBLE SHOOTING</b> .....	<b>33</b>
<b>9.</b>	<b>APPENDIX: APPROXIMATE BACK-UP TIME TABLE</b> .....	<b>34</b>

# 1 ABOUT THIS MANUAL

## 1.1 Purpose

This manual describes the assembly, installation, operation and troubleshooting of this unit. Please read this manual carefully before installations and operations. Keep this manual for future reference.

## 1.2 Scope

This manual provides safety and installation guidelines as well as information on tools and wiring.

# 2 SAFETY INSTRUCTIONS



**WARNING: This chapter contains important safety and operating instructions. Read and keep this manual for future reference.**

1. Before using the unit, read all instructions and cautionary markings on the unit, the batteries and all appropriate sections of this manual.
2. **CAUTION** --To reduce risk of injury, charge only deep-cycle lead acid type rechargeable batteries. Other types of batteries may burst, causing personal injury and damage.
3. Do not disassemble the unit. Take it to a qualified service center when service or repair is required. Incorrect re-assembly may result in a risk of electric shock or fire.
4. To reduce risk of electric shock, disconnect all wirings before attempting any maintenance or cleaning. Turning off the unit will not reduce this risk.
5. **CAUTION** – Only qualified personnel can install this device with battery.
6. **NEVER** charge a frozen battery.
7. For optimum operation of this inverter/charger, please follow required spec to select appropriate cable size. It's very important to correctly operate this inverter/charger.
8. Be very cautious when working with metal tools on or around batteries. A potential risk exists to drop a tool to spark or short circuit batteries or other electrical parts and could cause an explosion.
9. Please strictly follow installation procedure when you want to disconnect AC or DC terminals. Please refer to INSTALLATION section of this manual for the details.
10. One piece of 150A fuse is provided as over-current protection for the battery supply.
11. **GROUNDING INSTRUCTIONS** -This inverter/charger should be connected to a permanent grounded wiring system. Be sure to comply with local requirements and regulation to install this inverter.
12. **NEVER** cause AC output and DC input short circuited. Do NOT connect to the mains when DC input short circuits.
13. **Warning!!** Only qualified service persons are able to service this device. If errors still persist after following troubleshooting table, please send this inverter/charger back to local dealer or service center for maintenance.

### 3 INTRODUCTION

This is a multi-function inverter/charger, combining functions of inverter, solar charger and battery charger to offer uninterruptible power support with portable size. Its comprehensive LCD display offers user-configurable and easy-accessible button operation such as battery charging current, AC/solar charger priority, and acceptable input voltage based on different applications.

#### 3.1 Features

- ☒ Pure sine wave inverter
- ☒ Configurable input voltage range for home appliances and personal computers via LCD setting
- ☒ Configurable battery charging current based on applications via LCD setting
- ☒ Configurable AC/Solar Charger priority via LCD setting
- ☒ Compatible to mains voltage or generator power
- ☒ Auto restart while AC is recovering
- ☒ Overload/ Over temperature/ short circuit protection
- ☒ Smart battery charger design for optimized battery performance
- ☒ Cold start function

#### 3.2 Basic System Architecture

The following illustration shows basic application for this inverter/charger. It also includes following devices to have a complete running system:

- ☒ Generator or Utility.
- ☒ PV modules

Consult with your system integrator for other possible system architectures depending on your requirements. This inverter can power all kinds of appliances in home or office environment, including motor-type appliances such as tube light, fan, refrigerator and air conditioner.

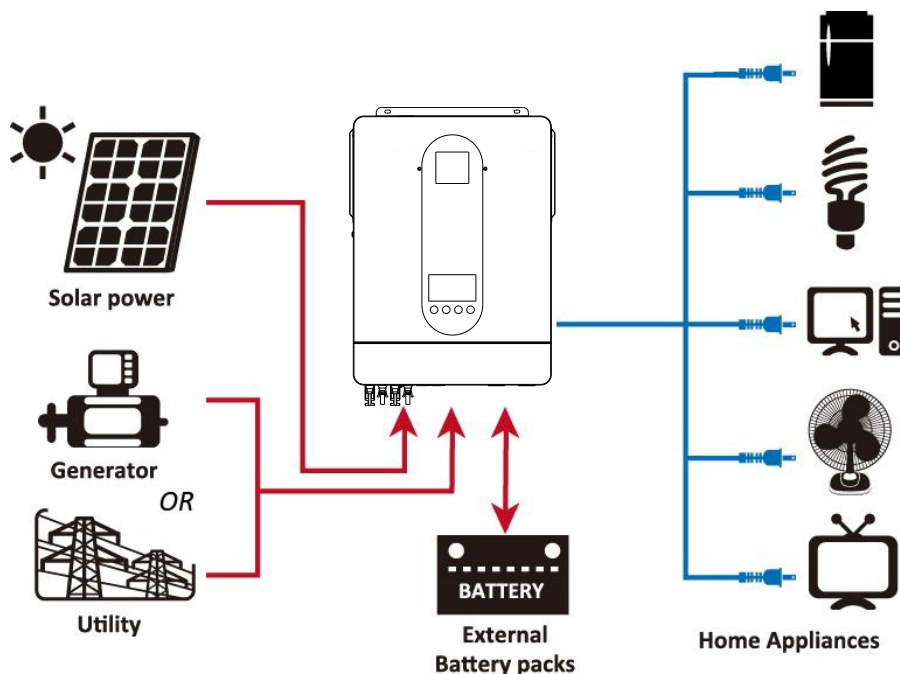

### 3.3 Product Overview

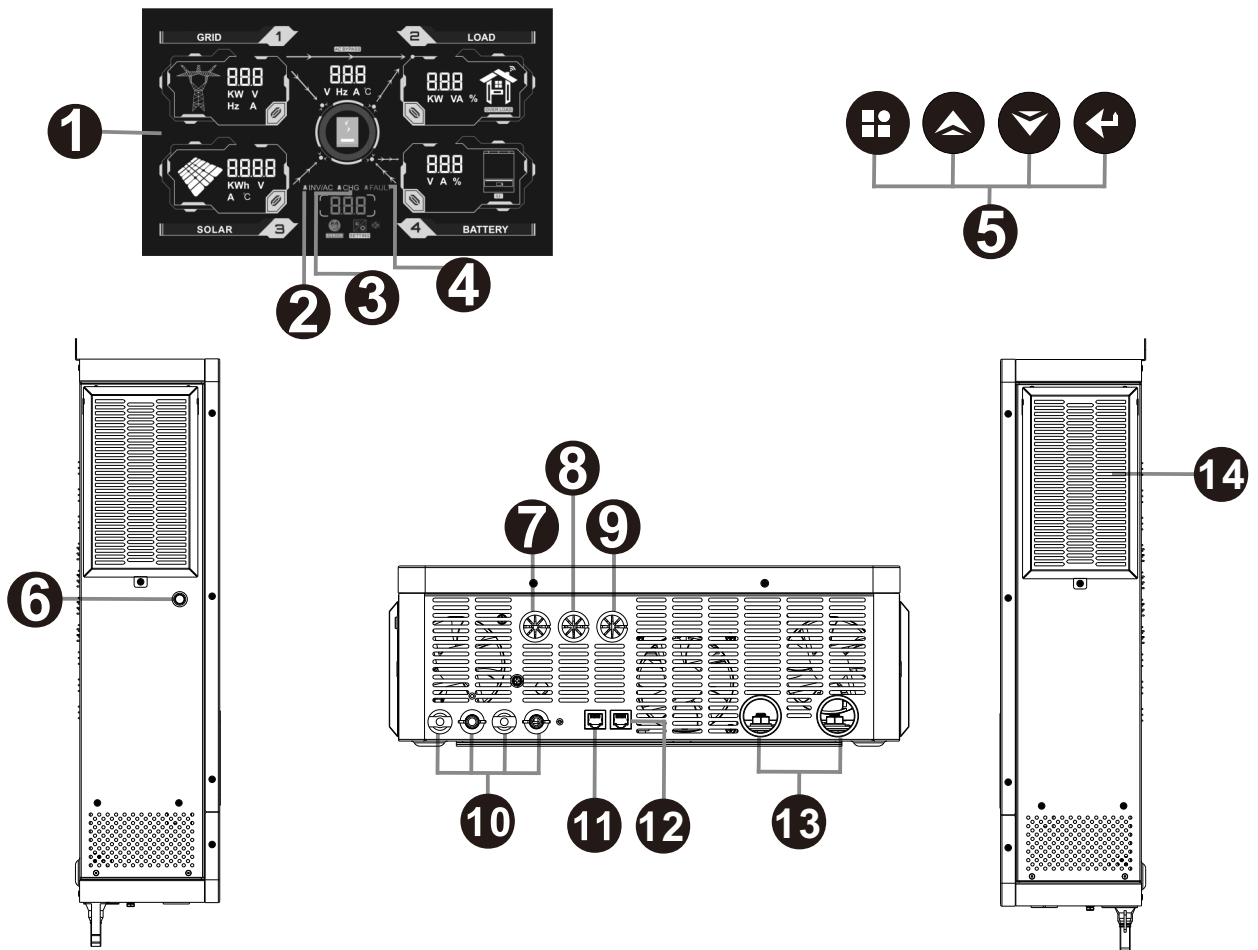

1. LCD display
2. Status indicator
3. Charging indicator
4. Fault indicator
5. Touch Function buttons
6. Power on/off switch
7. AC input
8. Main output
9. Second output
10. PV1 and PV2 input
11. WIFI communication/RS-232 port
12. Battery communication/RS-485 port
13. Battery input
14. Anti dust kit

## 4 INSTALLATION

### 4.1 Unpacking and Inspection

Before installation, please inspect the unit. Be sure that nothing inside the package is damaged. You should have received the following items inside of package:

- ☑ The unit x 1
- ☑ User manual x 1
- ☑ Ring terminal x 1
- ☑ Mc4 terminal head x 2

### 4.2 Preparation

Before connecting all wirings, please take off bottom cover by removing two screws as shown below.

### 4.3 Mounting the Unit

Consider the following points before selecting where to install:

- ⌘ Do not mount the inverter on flammable construction materials.
- ⌘ Mount on a solid surface
- ⌘ Install this inverter at eye level in order to allow the LCD display to be read at all times.
- ⌘ For proper air circulation to dissipate heat, allow a clearance of approx. 20 cm to the side and approx. 50 cm above and below the unit.
- ⌘ The ambient temperature should be between 0°C and 55°C to ensure optimal operation.
- ⌘ The recommended installation position is to be adhered to the wall vertically.
- ⌘ Be sure to keep other objects and surfaces as shown in the diagram to guarantee sufficient heat dissipation and to have enough space for removing wires.

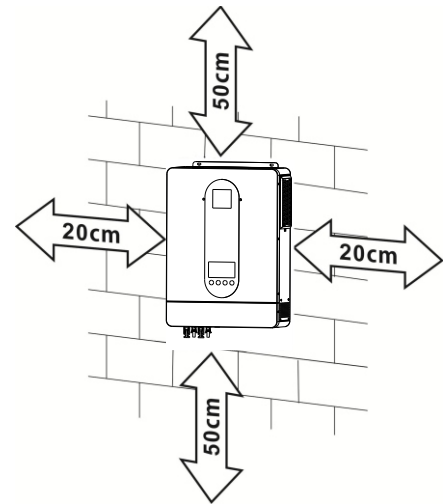

**SUITABLE FOR MOUNTING ON CONCRETE OR OTHER NON-COMBUSTIBLE SURFACE ONLY.**

Install the unit by screwing two screws. It's recommended to use M4 or M5 screws.

### 4.4 Battery Connection

**CAUTION:** For safety operation and regulation compliance, it's requested to install a separate DC over-current protector or disconnect device between battery and inverter. It may not be requested to have a disconnect device in some applications, however, it's still requested to have over-current protection installed. Please refer to typical amperage in below table as required fuse or breaker size.

**WARNING!** All wiring must be performed by a qualified personnel.

**WARNING!** It's very important for system safety and efficient operation to use appropriate cable for battery connection. To reduce risk of injury, please use the proper recommended cable as below.

**Recommended battery cable size:**

Model	Wire Size	Cable (mm <sup>2</sup> )	Torque value (max)
8.2KW/10.2KW	1 x 2AWG	25	2 Nm

Please follow below steps to implement battery connection:

1. Remove insulation sleeve 18 mm for positive and negative conductors.
2. Suggest to put bootlace ferrules on the end of positive and negative wires with a proper crimping tool.

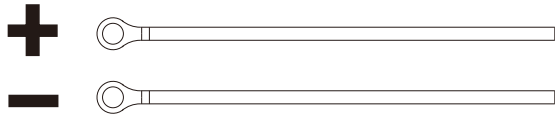

3. Connect all battery packs as below chart.

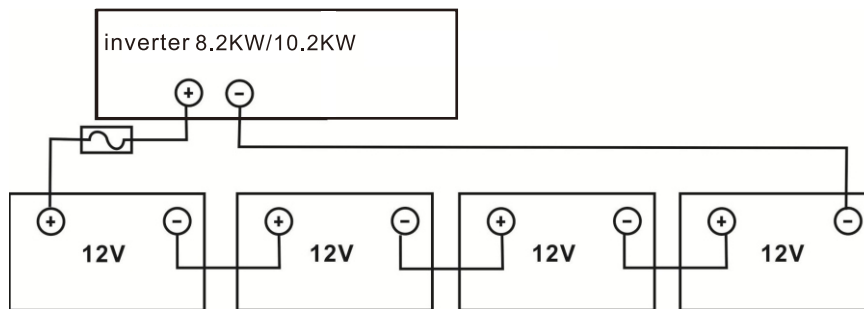

4. Insert the battery wires flatly into battery connectors of inverter and make sure the bolts are tightened with torque of 2 Nm in clockwise direction. Make sure polarity at both the battery and the inverter/charge is correctly connected and conductors are tightly screwed into the battery terminals.

Recommended tool: #2 Pozi Screwdriver

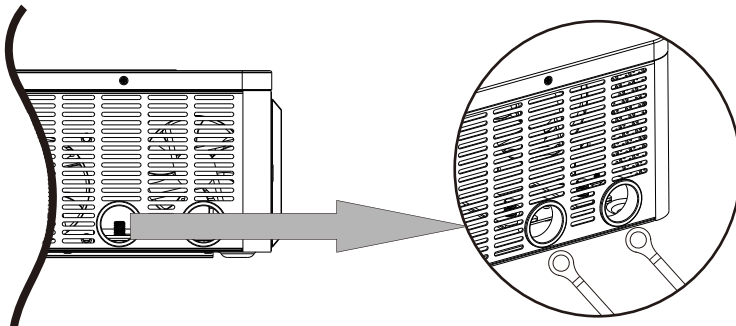

	<b>WARNING: Shock Hazard</b> Installation must be performed with care due to high battery voltage in series.
	<b>CAUTION!!</b> Before making the final DC connection or closing DC breaker/disconnector, be sure positive (+) must be connected to positive (+) and negative (-) must be connected to negative (-).

#### 4.5 AC Input/Output Connection

**CAUTION!!** Before connecting to AC input power source, please install a **separate** AC breaker between inverter and AC input power source. This will ensure the inverter can be securely disconnected during maintenance and fully protected from over current of AC input. The recommended spec of AC breaker is 63A for 8.2KW/10.2KW.

**CAUTION!!** There are two terminal blocks with "IN" and "OUT" markings. Please do NOT mis-connect input and output connectors.

**WARNING!** All wiring must be performed by a qualified personnel.

**WARNING!** It's very important for system safety and efficient operation to use appropriate cable for AC input connection. To reduce risk of injury, please use the proper recommended cable size as below.

#### Suggested cable requirement for AC wires

Model	Gauge	Cable (mm <sup>2</sup> )	Torque Value
8.2KW/10.2KW	10 AWG	6	1.2 Nm

Please follow below steps to implement AC input/output connection:

1. Before making AC input/output connection, be sure to open DC protector or disconnecter first.
2. Remove insulation sleeve 10mm for six conductors. And shorten phase L and neutral conductor N 3 mm.
3. Insert AC input wires according to polarities indicated on terminal block and tighten the terminal screws. Be sure to connect PE protective conductor (⊕) first.

- ⊕ → **Ground (yellow-green)**
- L → **LINE (brown or black)**
- N → **Neutral (blue)**

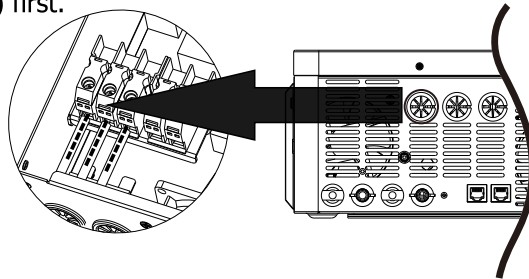

	<p><b>WARNING:</b> Be sure that AC power source is disconnected before attempting to hardwire it to the unit.</p>
-------------------------------------------------------------------------------------	-----------------------------------------------------------------------------------------------------------------------

4. Then, insert AC output wires according to polarities indicated on terminal block and tighten terminal screws.
  - L → **LINE (brown or black)**
  - N → **Neutral (blue)**

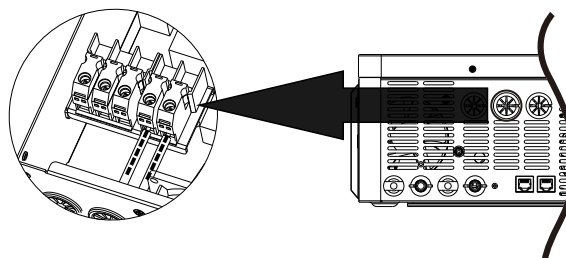

4. Then, insert AC output wires according to polarities indicated on terminal block and tighten terminal screws.
  - L → **LINE (brown or black)**
  - N → **Neutral (blue)**

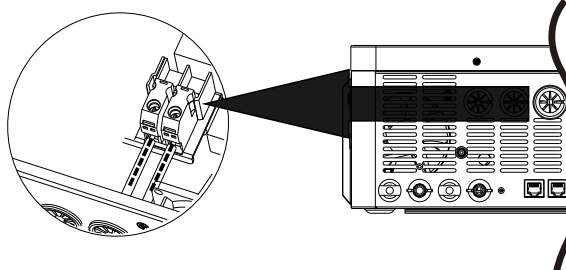

5. Make sure the wires are securely connected.



**CAUTION:** Appliances such as air conditioner are required at least 2~3 minutes to restart because it's required to have enough time to balance refrigerant gas inside of circuits. If a power shortage occurs and recovers in a short time, it will cause damage to your connected appliances. To prevent this kind of damage, please check manufacturer of air conditioner if it's equipped with time-delay function before installation. Otherwise, this inverter/charger will trig overload fault and cut off output to protect your appliance but sometimes it still causes internal damage to the air conditioner.

#### 4.6 PV Connection

**CAUTION:** Before connecting to PV modules, please install **separately** a DC circuit breaker between inverter and PV modules.

**WARNING!** It's very important for system safety and efficient operation to use appropriate cable for PV module connection. To reduce risk of injury, please use the proper recommended cable size as below.

Model	Wire Size	Cable (mm <sup>2</sup> )	Torque value (max)
8.2KW/10.2KW	1 x 10AWG	6	1.2 Nm

#### PV Module Selection:

When selecting proper PV modules, please be sure to consider below parameters:

1. Open circuit Voltage (Voc) of PV modules not exceeds max. PV array open circuit voltage of inverter.
2. Open circuit Voltage (Voc) of PV modules should be higher than min. battery voltage.

<b>INVERTER MODEL</b>	8.2KW/10.2KW
<b>Max. PV Array Open Circuit Voltage</b>	500Vdc
<b>PV Array MPPT Voltage Range</b>	90Vdc~450Vdc

Take 250Wp PV module as an example. After considering above two parameters, the recommended module configurations are listed as below table.

Solar Panel Spec. (reference)	SOLAR INPUT		Q'ty of panels	Total input power
	(Min in serial: 6 pcs, max. in serial: 13 pcs)			
- 250Wp	6 pcs in serial		6 pcs	1500W
- Vmp: 30.1Vdc	8 pcs in serial		8 pcs	2000W
- Imp: 8.3A	12 pcs in serial		12 pcs	3000W
- Voc: 37.7Vdc	13 pcs in serial		13 pcs	3250W
- Isc: 8.4A	12 pieces in serial and 3 sets in parallel		36 pcs	8200W
- Cells: 60	10 pieces in serial and 4 sets in parallel		40 pcs	10200W

#### PV Module Wire Connection

Step 1: Check the input voltage of PV array modules. The acceptable input voltage of the inverter is 120VDC - 500VDC. Please make sure that the maximum current load of each PV input connector is 10A.

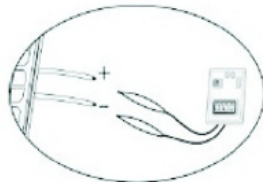





**CAUTION:** Exceeding the maximum input voltage can destroy the unit!! Check the system before wire connection.

Step 2: Disconnect the DC circuit breaker.

Step 3: Assemble provided PV connectors with PV modules by the following below steps.

**Components for PV connectors and Tools:**

Female connector housing		Male terminal	
Female terminal		Crimping tool and spanner	
Male connector housing			

**Cable preparation and connector assembly process:**

Strip one cable 8 mm on both end sides and be careful NOT to nick conductors.

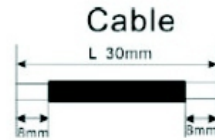

Insert striped cable into female terminal and crimp female terminal as shown below charts.



Insert assembled cable into female connector housing as shown below charts.

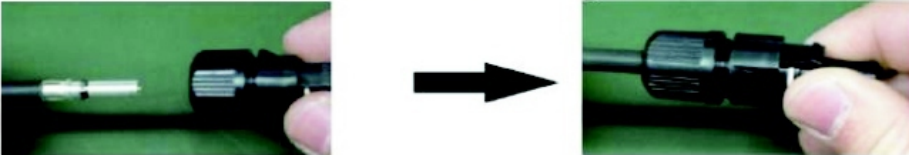

Insert striped cable into male terminal and crimp male terminal as shown below charts.



Insert assembled cable into male connector housing as shown below charts.

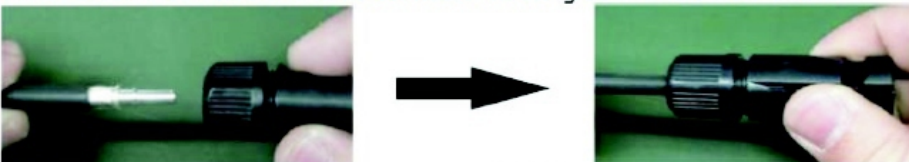

Then, use spanner to screw pressure dome tightly to female connector and male connector as shown below.

Step 4: Check correct polarity of connection cable from PV modules and PV input connectors. Then, connect positive pole (+) of connection cable to positive pole (+) of PV input connector. Connect negative pole (-) of connection cable to negative pole (-) of PV input connector.

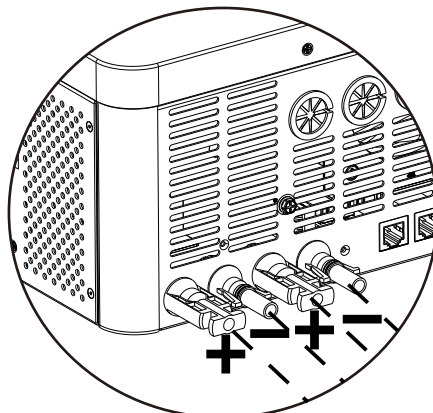

## 4.7 Final Assembly

After connecting all wirings, please put bottom cover back by screwing two screws as shown below.

## 4.8 Communication Connection

### 1. Wi-Fi cloud communication (option):

Please use supplied communication cable to connect to inverter and Wi-Fi module. Download APP and installed from APP store, and Refer to "Wi-Fi Plug Quick Installation Guideline" to set up network and registering. The inverter status would be shown by mobile phone APP or webpage of computer.

### 2. GPRS cloud communication (option):

Please use supplied communication cable to connect to inverter and GPRS module, and then applied external power to GPRS module. Download APP and installed from APP store, and Refer to "GPRS RTU Quick Installation Guideline" to set up network and registering. The inverter status would be shown by mobile phone APP or webpage of computer.

### 3. Battery communication

The communication between the battery and the inverter can be realized through the battery communication interface, so that the inverter and the lithium battery can exchange information.

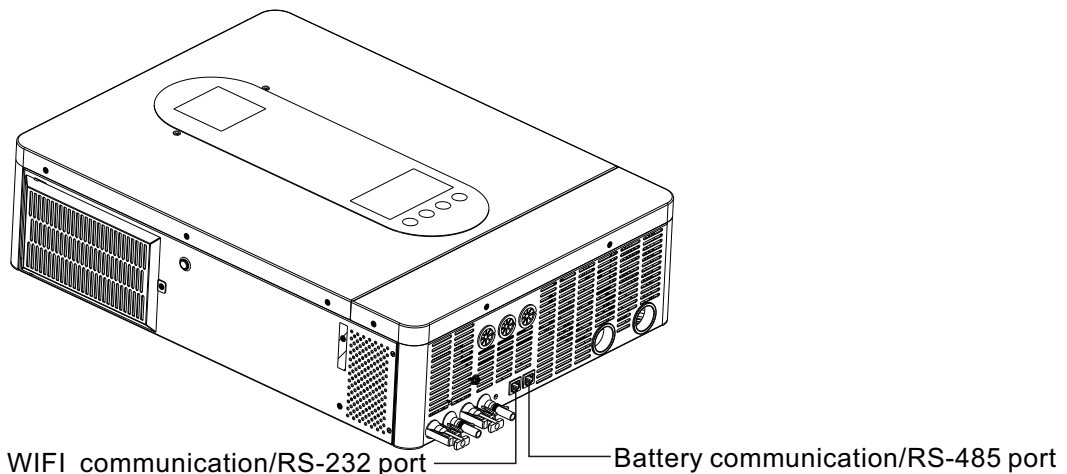

## 5 OPERATION

### 5.1 Power ON/OFF

Side view of unit

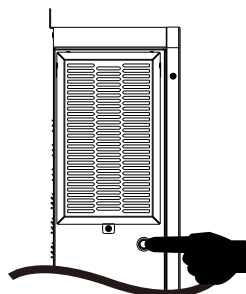

Once the unit has been properly installed and the batteries are connected well, simply press On/Off switch (located on the button of the case) to turn on the unit.

### 5.2 Operation and Display Panel

The operation and display panel, shown in below chart, is on the front panel of the inverter. It includes three indicators, four function keys and a LCD display, indicating the operating status and input/output power information.



LCD display

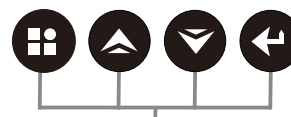

Function keys

### LED Indicator

LED Indicator		Messages	
<b>INV/AC</b>	Green	Solid On	Output is powered by utility in Line mode.
		Flashing	Output is powered by battery or PV in battery mode.
<b>CHG</b>	Green	Solid On	Battery is fully charged.
		Flashing	Battery is charging.
<b>FAULT</b>	Red	Solid On	Fault occurs in the inverter.
		Flashing	Warning condition occurs in the inverter.











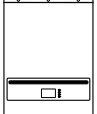

### Function Keys

Function Key	Description
ESC	To exit setting mode
UP	To go to previous selection
DOWN	To go to next selection
ENTER	To confirm the selection in setting mode or enter setting mode

### 5.3 LCD Display Icons



Icon	Function description
<b>Input Source Information</b>	
	Indicates the AC input.
	Indicates the PV input
 KW V Hz A	Indicate input voltage, input frequency, PV voltage, charger current (if PV in charging for 10.2KW models), charger power, battery voltage.

Configuration Program and Fault Information	
	Indicates the setting programs.
	Indicates the warning and fault codes. Warning: <b>888</b>  flashing with warning code. Fault: <b>888</b>  lighting with fault code
Output Information	
	Indicate output voltage, output frequency, load percent, load in VA, load in Watt and discharging current.
Battery Information	
	
Load Information	
	Indicates overload.
Mode Operation Information	
	Indicates unit connects to the mains.
	Indicates unit connects to the PV panel.
	Indicates load is supplied by utility power.
	Indicates the utility charger circuit is working.
	Indicates the DC/AC inverter circuit is working.
Mute Operation	
	Indicates unit alarm is disabled.

#### 5.4 LCD Setting

After pressing and holding ENTER button for 3 seconds, the unit will enter setting mode. Press "UP" or "DOWN" button to select setting programs. And then, press "ENTER" button to confirm the selection or ESC button to exit.

**Setting Programs:**

Program	Description	Selectable option	
00	Exit setting mode	Escape (default) 00 <u>GOE</u>	One-button restore setting options
		00 <u>GOH</u>	
01	Output source priority: To configure load power source priority	Utility first 01 <u>USb</u>	Utility will provide power to the loads as first priority. Solar and battery energy will provide power to the loads only when utility power is not available.
		Solar first (default) 01 <u>SUb</u>	Solar energy provides power to the loads as first priority. If solar energy is not sufficient to power all connected loads, utility will supply power to the loads at the same time. Battery provides power to the loads only when any one condition happens: - Solar energy and utility is not available. - Solar energy is not sufficient and utility is not available.
		SBU priority 01 <u>SbU</u>	Solar energy provides power to the loads as first priority. If solar energy is not sufficient to power all connected loads, battery energy will supply power to the loads at the same time. Utility provides power to the loads only when battery voltage drops to either low-level warning voltage or the setting point in program 12.
		MKS priority 01 <u>nT5</u>	Solar energy provides power to the loads as first priority, if solar energy is not sufficient to power all connected loads, utility energy will supply power to the loads at the same time. The battery only supplies energy to the load as a backup power.
02	Maximum charging current: To configure total charging current for solar and utility chargers. (Max. charging current = utility charging current + solar charging current)	10A 02 <u>10<sup>A</sup></u>	20A 02 <u>20<sup>A</sup></u>
		30A 02 <u>30<sup>A</sup></u>	40A 02 <u>40<sup>A</sup></u>

02		50A 02 50 <sup>A</sup>	60A 02 60 <sup>A</sup>	70A 02 70 <sup>A</sup>	80A 02 80 <sup>A</sup>
		90A 02 90 <sup>A</sup>	100A (default) 02 100 <sup>A</sup>	110A 02 110 <sup>A</sup>	120A 02 120 <sup>A</sup>
		130A 02 130 <sup>A</sup>	140A 02 140 <sup>A</sup>	150A 02 150 <sup>A</sup>	160A 02 160 <sup>A</sup>
03	AC input voltage range	Appliances (default) 03 APL	If selected, acceptable AC input voltage range will be within 90-280VAC.		
		UPS 03 UPS	If selected, acceptable AC input voltage range will be within 170-280VAC.		
05	Battery type	AGM (default) 05 AGM	Flooded 05 FLD		
		User-Defined 05 USE	If "User-Defined" is selected, battery charge voltage and low DC cut-off voltage can be set up in program 26, 27 and 29.		
		User-Defined 05 LIB	When the solar energy exists, Set this item to LIB, and the lithium battery will be activated for 3 second.		
		User-Defined 05 LIC	If selected, Lithium battery communication connection for PACE 232 BMS. The lithium battery activation function is automatically enabled. (LIB function has built in)		
		User-Defined 05 LIP	If selected, Lithium battery communication connection for PACE 485 BMS. The lithium battery activation function is automatically enabled. (LIB function has built in)		
		User-Defined 05 LIL	If selected, Lithium battery communication connection for PYLON 485 BMS. The lithium battery activation function is automatically enabled. (LIB function has built in)		
06	Auto restart when overload occurs	Restart disable (default) 06 LFD	Restart enable 06 LFE		
07	Auto restart when over temperature occurs	Restart disable (default) 07 tFd	Restart enable 07 tFE		
09	Output frequency	50Hz (default) 09 50 <sup>Hz</sup>	60Hz 09 60 <sup>Hz</sup>		
10	Output voltage	220V 10 220 <sup>v</sup>	230V (default) 10 230 <sup>v</sup>		
		240V 10 240 <sup>v</sup>			
11	Maximum utility charging current	2A 11 2A	10A 11 10A	20A 11 20A	

	<p>Note: If setting value in program 02 is smaller than that in program in 11, the inverter will apply charging current from program 02 for utility charger.</p>	30A 11 30A	40A 11 40A	50A 11 50A	
		60A 11 60A	70A 11 70A	80A (default) 11 80A	
		90A 11 90A	100A 11 100A	110A 11 110A	
		130A 11 130A	140A 11 140A	120A 11 120A	
12	<p>Setting voltage point back to utility source when selecting "SBU priority" or "Solar first" in program 01.</p>	Available options in 8.2KW/10.2KW model:			
		42V 12 BATT 42 <sup>v</sup>	43V 12 BATT 43 <sup>v</sup>	44V 12 BATT 44 <sup>v</sup>	
		45V 12 BATT 45 <sup>v</sup>	46V (default) 12 BATT 46 <sup>v</sup>	47V 12 BATT 47 <sup>v</sup>	
		48V 12 BATT 48 <sup>v</sup>	49V 12 BATT 49 <sup>v</sup>		
		50V 12 BATT 50 <sup>v</sup>	51V 12 BATT 51 <sup>v</sup>		
13	<p>Setting voltage point back to battery mode when selecting "SBU priority" or "Solar first" in program 01.</p>	Available options in 8.2KW/10.2KW model:			
		Battery fully charged 13 BATT FUL	48V 13 BATT 480 <sup>v</sup>		
		49V 13 BATT 490 <sup>v</sup>	50V 13 BATT 500 <sup>v</sup>		
		51V 13 BATT 510 <sup>v</sup>	52V 13 BATT 520 <sup>v</sup>		
		53V 13 BATT 530 <sup>v</sup>	54V (default) 13 BATT 540 <sup>v</sup>		



		55V 13 <u>55.0</u> <sup>BATT</sup> v	56V 13 <u>56.0</u> <sup>BATT</sup> v
		57V 13 <u>57.0</u> <sup>BATT</sup> v	58V 13 <u>58.0</u> <sup>BATT</sup> v
16	Charger source priority: To configure charger source priority	If this inverter/charger is working in Line, Standby or Fault mode, charger source can be programmed as below:	
		Solar first 16 <u>C50</u>	Solar energy will charge battery as first priority. Utility will charge battery only when solar energy is not available.
		Solar and Utility (default) 16 <u>SNU</u>	Solar energy and utility will charge battery at the same time.
		Only Solar 16 <u>O50</u>	Solar energy will be the only charger source no matter utility is available or not.
		If this inverter/charger is working in Battery mode or Power saving mode, only solar energy can charge battery. Solar energy will charge battery if it's available and sufficient.	
18	Alarm control	Alarm on (default) 18 <u>60N</u>	Alarm off 18 <u>60F</u>
19	Auto return to default display screen	Return to default display screen (default) 19 <u>ESP</u>	If selected, no matter how users switch display screen, it will automatically return to default display screen (Input voltage /output voltage) after no button is pressed for 1 minute.
		Stay at latest screen 19 <u>LEP</u>	If selected, the display screen will stay at latest screen user finally switches.
20	Backlight control	Backlight on (default) 20 <u>LON</u>	Backlight off 20 <u>LOF</u>

22	Beeps while primary source is interrupted	Alarm on (default) 22 AON	Alarm off 22 AOF
23	Overload bypass: When enabled, the unit will transfer to line mode if overload occurs in battery mode.	Bypass disable (default) 23 byd	Bypass enable 23 byE
25	Record Fault code	Record enable (default) 25 FEN	Record disable 25 FdS
26	Bulk charging voltage (C.V voltage)	8.2KW/10.2KW default setting: 56.4V CU 26 56.4 <sup>BATT</sup> v	
		If self-defined is selected in program 5, this program can be set up. Setting range is from 48.0V to 61.0V for 8.2KW/10.2KW model. Increment of each click is 0.1V.	
27	Floating charging voltage	8.2KW/10.2KW default setting: 54.0V FLU 27 54.0 <sup>BATT</sup> v	
		If self-defined is selected in program 5, this program can be set up. Setting range is from 48.0V to 61.0V for 8.2KW/10.2KW model. Increment of each click is 0.1V.	
29	Low DC cut-off voltage	8.2KW/10.2KW default setting: 40.0V COU 29 40.0 <sup>BATT</sup> v	
		If self-defined is selected in program 5, this program can be set up. Setting range is from 40.0V to 48.0V for 8.2KW/10.2KW model. Increment of each click is 0.1V. Low DC cut-off voltage will be fixed to setting value no matter what percentage of load is connected.	

30	Battery equalization	Battery equalization 30 <u>EEEN</u>	Battery equalization disable (default) 30 <u>EdS</u>
		If "Flooded" or "User-Defined" is selected in program 05, this program can be set up.	
31	Battery equalization voltage	8.2KW/10.2KW default setting: 58.4V <u>EV 31</u> <sup>BATT</sup> <u>58.4V</u>	
		Setting range is from 48.0V to 61.0V for 8.2KW/10.2KW model. Increment of each click is 0.1V.	
33	Battery equalized time	60min (default) 33 <u>60</u>	Setting range is from 5min to 900min. Increment of each click is 5min.
34	Battery equalized timeout	120min (default) 34 <u>120</u>	Setting range is from 5min to 900 min. Increment of each click is 5 min.
35	Equalization interval	30days (default) 35 <u>30d</u>	Setting range is from 0 to 90 days. Increment of each click is 1 day
36	Equalization activated immediately	Enable 36 <u>AEN</u>	Disable (default) 36 <u>AdS</u>
		If equalization function is enabled in program 30, this program can be set up. If "Enable" is selected in this program, it's to activate battery equalization immediately and LCD main page will shows "E9". If "Disable" is selected, it will cancel equalization function until next activated equalization time arrives based on program 35 setting. At this time, "E9" will not be shown in LCD main page.	
37	GRID-tie operation	Off grid (default) 37 <u>OFF</u>	Inverter operates only in off-grid mode. Solar energy provides power to the loads as first priority and charging second
		Feed to grid 37 <u>HYD</u>	Inverter operates Feed to grid mode. Solar energy provides power to the loads as first priority and charging second Excess energy feed to grid.

38	GRID-tie current	10A 38 10 <sup>A</sup>	Increment of each click is 2A.
39	Led pattern light	Led pattern off 39 L0F	Led pattern on(default) 39 L0N
41	Dual output	disable (default) 41 L2F	use 41 L20
42	Enter the dual output functional voltage point	8.2KW/10.2KW default setting: 44.0V 42 44.0	Setting range is from 40.0V to 52.0V for 48VDC model. Increment of each click is 0.1V.

### 5.5 Display Setting

The LCD display information will be switched in turns by pressing "UP" or "DOWN" key. The selectable information is switched as below order: input voltage, input frequency, PV voltage, charging current, charging power, battery voltage, output voltage, output frequency, load percentage, load in Watt, load in VA, load in Watt, DC discharging current, main CPU Version.

Selectable information	LCD display
<b>Charged state, and the power is less than 1kw</b>	
Input voltage=222V , PV voltage=168V, Battery voltage=25V, Output voltage=222V, Load in Watt=188W, Chg(Flashing), Inv/ac(bright)	
Input voltage=223V , PV current=2.3A, Battery current=20A, Output voltage=224V, Load in VA=188VA, Chg(Flashing), Inv/ac(bright)	

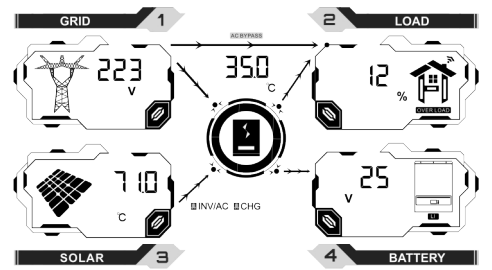
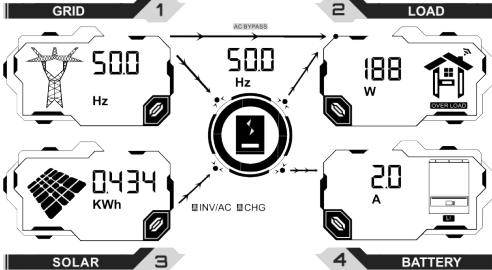
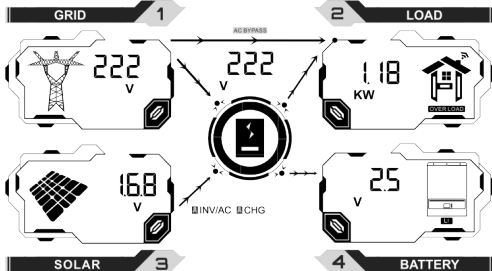
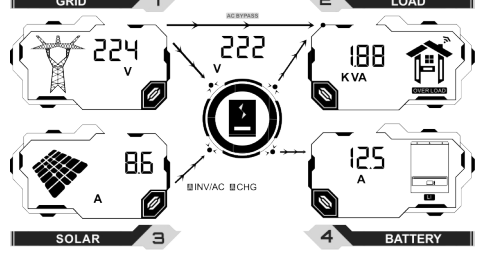
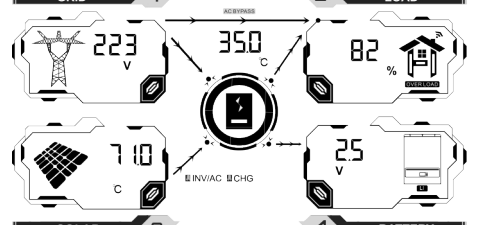
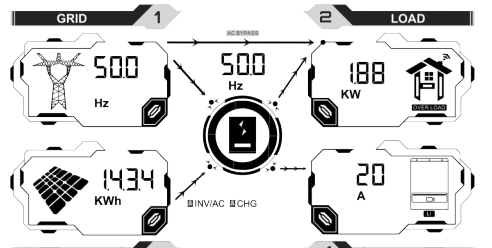
<p>Input voltage=223V ,  Pv ntc temperture=71.0°C,  Battery voltage= 25V,  Inv ntc temperture=35.0°C,  Load percentage=12% ,  Chg(Flashing), Inv/ac(bright)</p>	
<p>Input frequency=50.0Hz ,  PV power=0.434KWh,  Battery current=20A,  Output frequency=50.0Hz,  Load in watt=188W,  Chg(Flashing), Inv/ac(bright)</p>	
<p>Charged state, and the power is greater than 1kw</p>	
<p>Input voltage=222V ,  PV voltage=168V,  Battery voltage=25V,  Output voltage=222V,  Load in Watt=1.18KW,  Chg(Flashing), Inv/ac(bright)</p>	
<p>Input voltage=224V ,  PV current=8.6A,  Battery current=12.5A,  Output voltage=222V,  Load in VA=1.88KVA,  Chg(Flashing), Inv/ac(bright)</p>	
<p>Input voltage=223V ,  Pv ntc temperture=71.0°C,  Battery voltage=25V,  Inv ntc temperture=35.0°C,  Load percentage=82% ,  Chg(Flashing), Inv/ac(bright)</p>	
<p>Input frequency=50.0Hz ,  PV power=1.434KWh,  Battery current=20A,  Output frequency=50.0Hz,  Load in watt=1.88KW,  Chg(Flashing), Inv/ac(bright)</p>	

Discharged state, and the power is less than 1kw

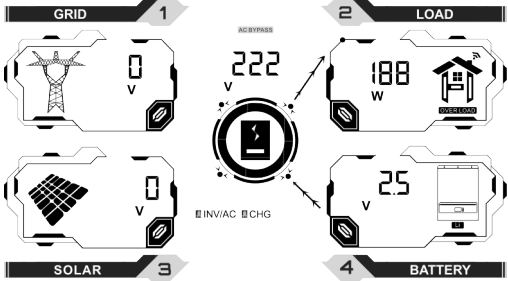
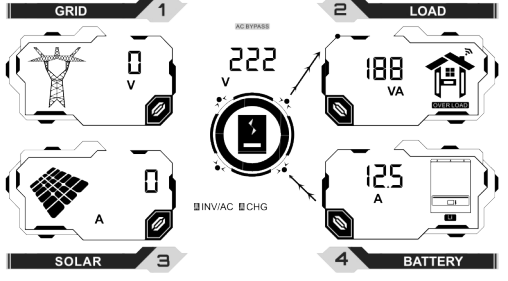
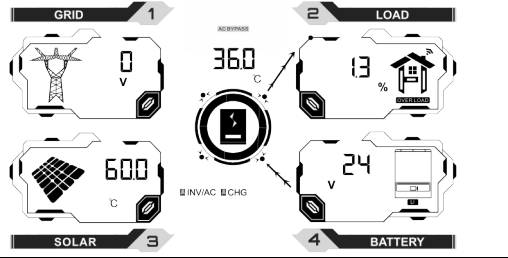
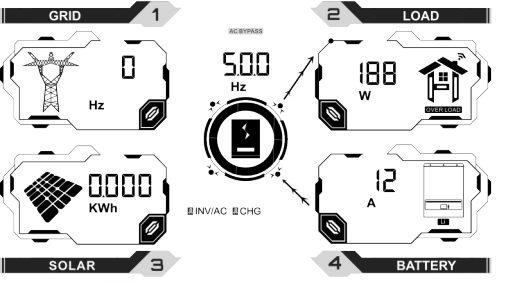
<p>Input voltage=0V ,                      PV voltage=0V,                      Battery voltage=25V,                      Output voltage=222V,                      Load in Watt=188W,                      Chg(turn off), Inv/ac(Flashing)</p>	
<p>Input voltage=0V ,                      PV current=0A,                      Battery current=12.5A,                      Output voltage=222V,                      Load in VA=188VA,                      Chg(turn off), Inv/ac(Flashing)</p>	
<p>Input voltage=0V ,                      Pv ntc temperture=60.0°C,                      Battery voltage=24V,                      Inv ntc temperture=36.0°C,                      Load percentage=13%,                      Chg(turn off), Inv/ac(Flashing)</p>	
<p>Input frequency=0Hz ,                      PV power=0KWh,                      Battery current=12A,                      Output frequency=50.0Hz,                      Load in watt=188W,                      Chg(turn off), Inv/ac(Flashing)</p>	

Discharged state, and the power is greater than 1kw

<p>Input voltage=0V ,                  PV voltage=0V,                  Battery voltage=25V,                  Output voltage=222V,                  Load in Watt=1.88KW,                  Chg(turn off), Inv/ac(Flashing)</p>	
<p>Input voltage=0V ,                  PV current=0A,                  Battery current=111A,                  Output voltage=222V,                  Load in VA=1.88KVA,                  Chg(turn off), Inv/ac(Flashing)</p>	
<p>Input voltage=0V ,                  Pv ntc temperture=68.0°C,                  Battery voltage= 24V,                  Inv ntc temperture=30.0°C,                  Load percentage=81%,                  Chg(turn off), Inv/ac(Flashing)</p>	
<p>Input frequency=0Hz ,                  PV power=0KWh,                  Battery current=111A,                  Output frequency=50.0Hz,                  Load in watt=1.21KW,                  Chg(turn off), Inv/ac(Flashing)</p>	
<p>Main CPU version checking</p>	<p>Main CPU version 21 05</p>

### 5.6 Operating Mode Description

Operation mode	Selectable information	LCD display
Stanby mode	Input voltage=222V , PV voltage=210V, Battery voltage=25V, Output voltage=0V, Load in Watt=0W, Chg(Flashing), Inv/ac(bright)	
	Input voltage=223V , PV voltage=0V, Battery voltage=25V, Output voltage=0V, Load in Watt=0W, Chg(Flashing), Inv/ac(bright)	
	Input voltage=0V , PV voltage=210V, Battery voltage=25V, Output voltage=0V, Load in Watt=0W, Chg(Flashing)	
Line mode	Input voltage=224V , PV current=8.6A, Battery current=12.5A, Output voltage=222V, Load in VA=1.88KVA, Chg(Flashing), Inv/ac(bright)	
	Input voltage=224V , PV voltage=0V, Battery voltage=25V, Output voltage=222V, Load in Watt=188W, Chg(Flashing), Inv/ac(bright)	
Grid-Tie Operation	Input voltage=224V , PV current=8.6A, Battery current=12.5A, Output voltage=222V, Load in VA=1.88KVA, Chg(Flashing), Inv/ac(bright)	<p data-bbox="834 1944 1399 2029">When working in Grid-Tie mode, the will be flash 3S/3times.</p>

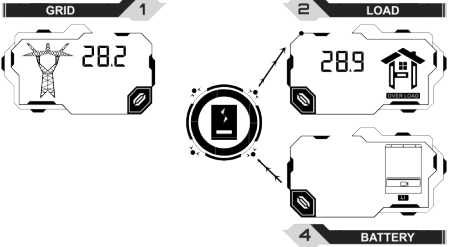
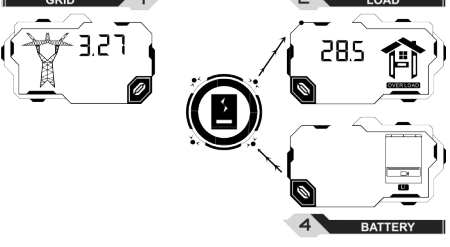

Operation mode	Selectable information	LCD display
Battery mode	Input voltage=0V , PV voltage=180V, Battery voltage=25V, Output voltage=230V, Load in Watt=388W, Inv/ac(Flashing)	
	Input voltage=0V , PV voltage=180V, Battery voltage=25V, Output voltage=230V, Load in Watt=388W, Chg(Flashing), Inv/ac(Flashing)	
<b>Selectable information</b>		<b>LCD display</b>
<b>LIC(Lithium battery communication connection)</b>		
	Total battery voltage=52.4V Battery residual capacity=23%	
	Battery charging current=0A Battery discharge current=1A	
	Nominal battery voltage=48V Total battery capacity=100AH	
	Battery remaining capacity=23% Battery charger/discharge Times =8	

<p>Battery ambient temperature=28.2°C Battery MOS temperature=28.9°C</p>	
<p>Single battery voltage=3.27V Single battery temperature=28.5°C</p>	

## RGB Light (option )

- ① **Battery Mode:red Light**
- ② **Utility Mode:blue Light**
- ③ **PV Mode:purple Light**

### 5.7 Battery Equalization Description

Equalization function is added into charge controller. It reverses the buildup of negative chemical effects like stratification, a condition where acid concentration is greater at the bottom of the battery than at the top. Equalization also helps to remove sulfate crystals that might have built up on the plates. If left unchecked, this condition, called sulfation, will reduce the overall capacity of the battery. Therefore, it's recommended to equalize battery periodically.

#### ⌘ How to Apply Equalization Function

You must enable battery equalization function in monitoring LCD setting program 30 first. Then, you may apply this function in device by either one of following methods:

1. Setting equalization interval in program 35.
2. Active equalization immediately in program 36.

#### ⌘ When to Equalize

In float stage, when the setting equalization interval (battery equalization cycle) is arrived, or equalization is active immediately, the controller will start to enter Equalize stage.

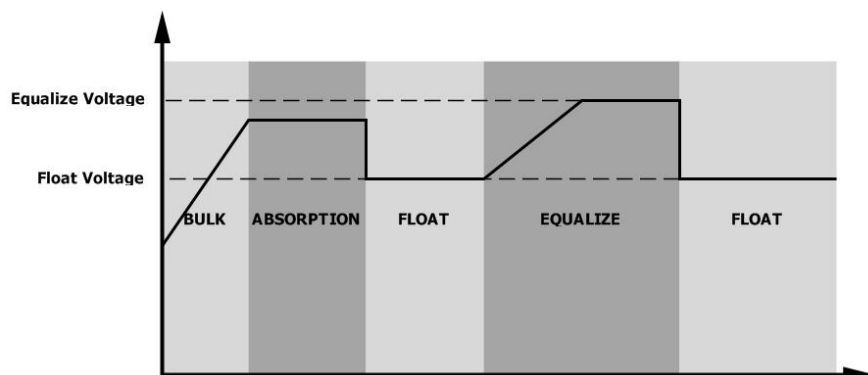

### ⌘ Equalize charging time and timeout

In Equalize stage, the controller will supply power to charge battery as much as possible until battery voltage raises to battery equalization voltage. Then, constant-voltage regulation is applied to maintain battery voltage at the battery equalization voltage. The battery will remain in the Equalize stage until setting battery equalized time is arrived.

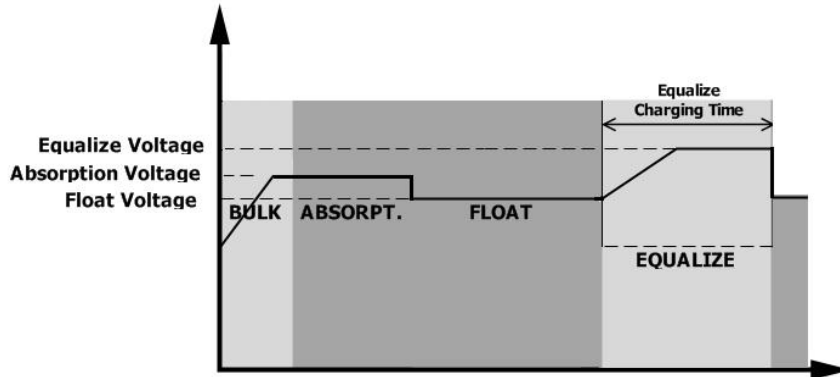

However, in Equalize stage, when battery equalized time is expired and battery voltage doesn't rise to battery equalization voltage point, the charge controller will extend the battery equalized time until battery voltage achieves battery equalization voltage. If battery voltage is still lower than battery equalization voltage when battery equalized timeout setting is over, the charge controller will stop equalization and return to float stage.

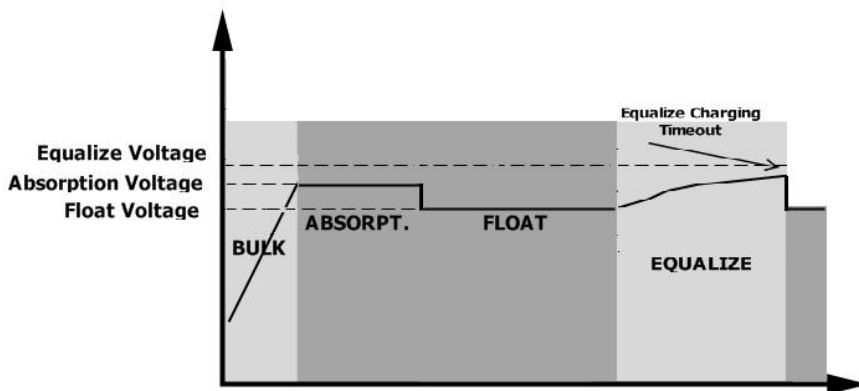









### 5.8 Fault Reference Code

Fault Code	Fault Event	Icon on
01	Fan is locked when inverter is off.	01 ERROR
02	Over temperature	02 ERROR
03	Battery voltage is too high	03 ERROR
04	Battery voltage is too low	04 ERROR
05	Output short circuited or over temperature is detected by internal converter components.	05 ERROR
06	Output voltage is too high.	06 ERROR
07	Overload time out	07 ERROR
08	Bus voltage is too high	08 ERROR
09	Bus soft start failed	09 ERROR
51	Over current or surge	51 ERROR

52	Bus voltage is too low	52 ERROR
53	Inverter soft start failed	53 ERROR
55	Over DC voltage in AC output	55 ERROR
57	Current sensor failed	57 ERROR
58	Output voltage is too low	58 ERROR
59	PV voltage is over limitation	59 ERROR

### 5.9 Warning Indicator

Warning Code	Warning Event	Audible Alarm	Icon flashing
01	Fan is locked when inverter is on.	Beep three times every second	01 
03	Battery is over-charged	Beep once every second	03 
04	Low battery	Beep once every second	04 
07	Overload	Beep once every 0.5 second	07 
10	Output power derating	Beep twice every 3 seconds	10 
15	PV energy is low.	Beep twice every 3 seconds	15 
E9	Battery equalization	None	E9 
bP	Battery is not connected	None	bP 

## 6 CLEARANCE AND MAINTENANCE FOR ANTI-DUST KIT

### 6.1 Overview

Every inverter is already installed with anti-dusk kit from factory. Inverter will automatically detect this kit and activate internal thermal sensor to adjust internal temperature. This kit also keeps dusk from your inverter and increases product reliability in harsh environment.

### 6.2 Clearance and Maintenance

**Step 1:** Please loosen the screw in counterclockwise direction on the top of the inverter.

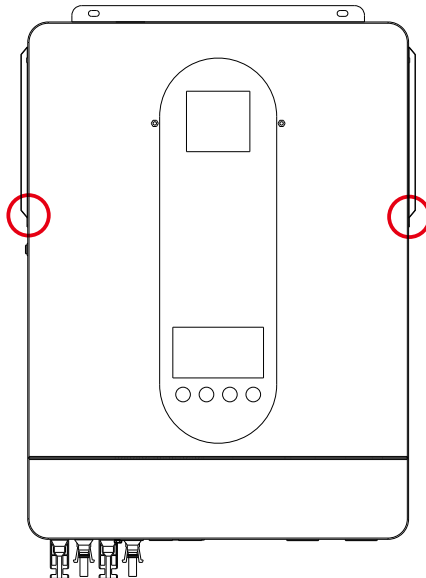

**Step 2:** Then, dustproof case can be removed and take out air filter foam as shown in below chart.

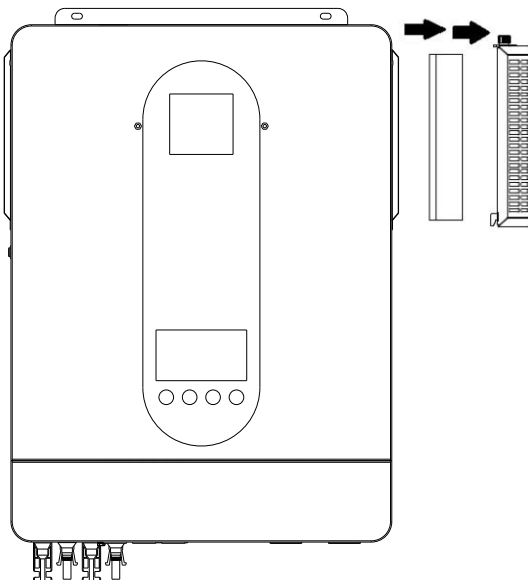

**Step 3:** Clean air filter foam and dustproof case. After clearance, re-assemble the dust-kit back to the inverter.

**NOTICE:** The anti-dust kit should be cleaned from dust every one month.

## 7 SPECIFICATIONS

Table 1 Line Mode Specifications

INVERTER MODEL	8.2KW	10.2KW
<b>Input Voltage Waveform</b>	Sinusoidal (utility or generator)	
<b>Nominal Input Voltage</b>	230Vac	
<b>Low Loss Voltage</b>	170Vac±7V (UPS); 90Vac±7V (Appliances)	
<b>Low Loss Return Voltage</b>	180Vac±7V (UPS); 100Vac±7V (Appliances)	
<b>High Loss Voltage</b>	280Vac±7V	
<b>High Loss Return Voltage</b>	270Vac±7V	
<b>Max AC Input Voltage</b>	300Vac	
<b>Nominal Input Frequency</b>	50Hz / 60Hz (Auto detection)	
<b>Low Loss Frequency</b>	40±1Hz	
<b>Low Loss Return Frequency</b>	42±1Hz	
<b>High Loss Frequency</b>	65±1Hz	
<b>High Loss Return Frequency</b>	63±1Hz	
<b>Output Short Circuit Protection</b>	Circuit Breaker	
<b>Efficiency (Line Mode)</b>	>95% ( Rated R load, battery full charged )	
<b>Transfer Time</b>	10ms typical (UPS); 20ms typical (Appliances)	
<p><b>Output power derating:</b> When AC input voltage drops to 170V, the output power will be derated.</p>	 <p>The graph illustrates the output power derating characteristics. The vertical axis represents Output Power, and the horizontal axis represents Input Voltage. Key points on the graph include:         <ul style="list-style-type: none"> <li>At 90V input, the output power is constant at 50% of the rated power.</li> <li>Between 90V and 170V, the output power increases linearly from 50% to 100% (Rated Power).</li> <li>From 170V to 280V, the output power remains constant at the Rated Power level.</li> <li>At 280V, the output power drops to zero.</li> </ul> </p>	

Table 2 Inverter Mode Specifications

<b>INVERTER MODEL</b>	<b>8.2KW</b>	<b>10.2KW</b>
<b>Rated Output Power</b>	8.2KW	10.2KW
<b>Output Voltage Waveform</b>	Pure Sine Wave	
<b>Output Voltage Regulation</b>	230Vac±5%	
<b>Output Frequency</b>	50Hz	
<b>Peak Efficiency</b>	93%	
<b>Overload Protection</b>	3s@≥150% load; 5s@101%~150% load	
<b>Surge Capacity</b>	2* rated power for 5 seconds	
<b>Nominal DC Input Voltage</b>	48Vdc	
<b>Cold Start Voltage</b>	46.0Vdc	
<b>Low DC Warning Voltage</b> @ load < 50% @ load ≥ 50%	44.0Vdc 42.0Vdc	
<b>Low DC Warning Return Voltage</b> @ load < 50% @ load ≥ 50%	45.0Vdc 44.0Vdc	
<b>Low DC Cut-off Voltage</b> @ load < 50% @ load ≥ 50%	41.0Vdc 40.0Vdc	
<b>High DC Recovery Voltage</b>	62Vdc	
<b>High DC Cut-off Voltage</b>	63Vdc	
<b>No Load Power Consumption</b>	70W	75W

Table 3 Two Load Output Power

<b>INVERTER MODEL</b>	<b>8.2KW</b>	<b>10.2KW</b>
<b>Full Load</b>	8200W	10200W
<b>Maximum Main Load</b>	8200W	10200W
<b>Maximum Second Load(battery model)</b>	2733W	3400W
<b>Main Load Cut Off Voltage</b>	52VDC	
<b>Main Load Return Voltage</b>	54VDC	

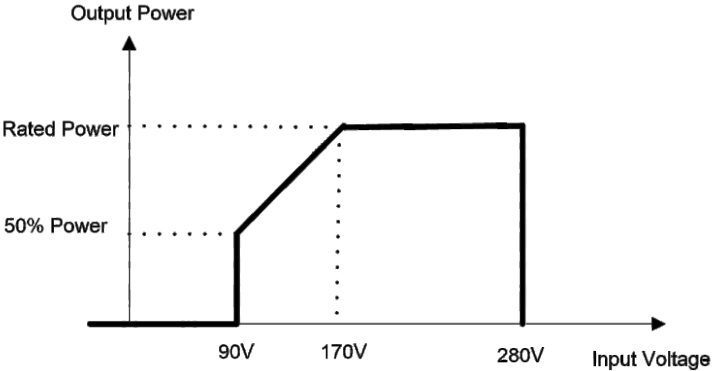
Table 4 Charge Mode Specifications

Utility Charging Mode		
INVERTER MODEL	8.2KW	10.2KW
Charging Algorithm	3-Step	
AC Charging Current (Max)	140Amp	140Amp
Bulk Charging Voltage	Flooded Battery	58.4
	AGM / Gel Battery	56.4
Floating Charging Voltage	54Vdc	
Charging Curve		
MPPT Solar Charging Mode		
INVERTER MODEL	8.2KW	10.2KW
Max. PV Array Power	PV1 Channel:5600W	PV1 Channel:6100W
	PV2 Channel:5600W	PV2 Channel:6100W
IMax.PV	PV1 Channel:18A	
	PV2 Channel:18A	
Nominal PV Voltage	360Vdc	
PV Array MPPT Voltage Range	90Vdc~450Vdc	
Max. PV Array Open Circuit Voltage	500Vdc	
Max Charging Current (AC charger plus solar charger)	160Amp	

Table 5 Grid-Tie Operation

INVERTER MODEL	8.2KW	10.2KW
Nominal Output Voltage	220/230/240 VAC	
Feed-in Grid Voltage Range	195 ~253VAC	
Feed-in Grid Frequency Range	49~51 ± 1Hz/59~61±1Hz	
Nominal Output Current	35.6A	44.3A
Power Factor Range	>0.99	
Maximum Conversion Efficiency (DC/AC)	98%	

Table 6 General Specifications

INVERTER MODEL	8.2KW	10.2KW
Safety Certification	CE	
Operating Temperature Range	-10°C to 50°C	
Storage temperature	-15°C~ 60°C	
Humidity	5% to 95% Relative Humidity (Non-condensing)	
Dimension (D*W*H), mm	530*390*130mm	
Net Weight, kg	14.2	14.5



## 8 TROUBLE SHOOTING

Problem	LCD/LED/Buzzer	Explanation / Possible cause	What to do
Unit shuts down automatically during startup process.	LCD/LEDs and buzzer will be active for 3 seconds and then complete off.	The battery voltage is too low (<1.91V/Cell)	1. Re-charge battery. 2. Replace battery.
No response after power on.	No indication.	1. The battery voltage is far too low. (<1.4V/Cell) 2. Internal fuse tripped.	1. Contact repair center for replacing the fuse. 2. Re-charge battery. 3. Replace battery.
Mains exist but the unit works in battery mode.	Input voltage is displayed as 0 on the LCD and green LED is flashing.	Input protector is tripped	Check if AC breaker is tripped and AC wiring is connected well.
	Green LED is flashing.	Insufficient quality of AC power. (Shore or Generator)	1. Check if AC wires are too thin and/or too long. 2. Check if generator (if applied) is working well or if input voltage range setting is correct. (UPS↔ Appliance)
	Green LED is flashing.	Set "Solar First" as the priority of output source.	Change output source priority to Utility first.
When the unit is turned on, internal relay is switched on and off repeatedly.	LCD display and LEDs are flashing	Battery is disconnected.	Check if battery wires are connected well.
Buzzer beeps continuously and red LED is on.	Fault code 07	Overload error. The inverter is overload 110% and time is up.	Reduce the connected load by switching off some equipment.
	Fault code 05	Output short circuited.	Check if wiring is connected well and remove abnormal load.
		Temperature of internal converter component is over 120°C.	Check whether the air flow of the unit is blocked or whether the ambient temperature is too high.
	Fault code 02	Internal temperature of inverter component is over 100°C.	
	Fault code 03	Battery is over-charged.	Return to repair center.
		The battery voltage is too high.	Check if spec and quantity of batteries are meet requirements.
	Fault code 01	Fan fault	Replace the fan.
	Fault code 06/58	Output abnormal (Inverter voltage below than 190Vac or is higher than 260Vac)	1. Reduce the connected load. 2. Return to repair center
	Fault code 08/09/53/57	Internal components failed.	Return to repair center.
	Fault code 51	Over current or surge.	Restart the unit, if the error happens again, please return to repair center.
Fault code 52	Bus voltage is too low.		
Fault code 55	Output voltage is unbalanced.		

## 9 Appendix: Approximate Back-up Time Table

Model	Load (W)	Backup Time @ 48Vdc 100Ah (min)	Backup Time @ 48Vdc 200Ah (min)
8.2KW 10.2KW	500	613	1288
	1000	268	613
	1500	158	402
	2000	111	271
	2500	90	215
	3200	76	182
	3500	65	141
	4000	50	112
	4500	44	100
	5000	40	90
	6200	36	80
	7200	32	70
	8200	28	60
	9200	24	50
	10200	20	40

**Note:** 1. Backup time depends on the quality of the battery, age of battery and type of battery.

Specifications of batteries may vary depending on different manufacturers.

2. The final interpretation right of this product belongs to the company.

**技术要求:**

- 1、尺寸:单页尺寸142\*210mm;
- 2、材质:封面105g铜版纸, 内页80g书写纸;
- 3、颜色:黑白印刷;
- 4、印刷效果:图片、字体、线条需清晰, 无重影, 无毛边, 无多余杂点;
- 5、料号打于后封面左下角;

公司名称:广东三瑞电源有限公司

设计:张群钗      日期:2024.07.30

**\*注:此技术要求不用印刷**

327-100328-01G